

MESSITEENUSED

2016

FAIR SERVICES



www.fair.ee

Tere tulemast Eesti Näituste messikeskusesse, Eesti suurimasse messikeskusesse!



Hoiad käes Eesti suurima messikeskuse tellimispaketti. Siit leiad kõik vajaliku messide ja näituste tarbeks. Meie teenuste laik valik loob Teile kõik võimalused, et messidel osalemine oleks õnnestunud ja tulemusrikas.

Tulemusrikas messidel ja näitustel osalemine eeldab hoolsat eelplaneerimist ja mitmete erialaspetsialistide laitmatut koostööd. Meilt saad asjatundlikku ja kvaliteetset teenust alates stendi kujundusest kuni teostuseni. Meie spetsialistide ja koostööpartnerite abil saad korrigeerida kogu messitegevust. Nii võid olla

kindel, et õige teave jõuab kohale, õiged kontaktid kohtuvad ja et see viib ka reaalse tulemusteni.

Käesolevast paketist leiad kõik meie pakutavad teenused.

Vajadused on alati individuaalsed, koos saavutame parima tulemuse.

Võta meiega ühendust ning muudame koos messil osalemise kordaläinuks!

We welcome you to the Estonian Fairs Centre, Estonian biggest fair centre!



You are holding the service guide of Estonian biggest fair organizer. In this guide you'll find everything you need to get the best out of the fair media, exhibitions and events. Our wide range of services helps you ensure that your presence in the facilities of the Estonian Fairs Centre is successful and productive.

Successful participation in fairs and events calls for careful planning and seamless cooperation from professionals in many different fields. We can help you with expert services from professionals in

designing and setting up stands. With the help of our professionals and experienced partners you'll be able to control the entire fair and event process. In this way you'll be able to ensure that correct information is communicated, that the right contacts are made – and that the contacts lead to results. Our brochure introduces our extensive range of services.

Each exhibitor has different needs: the best result is achieved by planning together.

Get in touch with us: let's join forces to turn your participation into a success story!

Sisukord / Contents

Stendi kujundamine / Stand design	4
Erikujuline stend / Design stand	5
Standardstend / Standard stand	6
Profiilide ja kilpide mõõdud/Dimensions of profiles and panels	7
Konstruksioonelemendid / Constructions	8
Mööbel / Furniture	9
Vaipkatted / Carpets	13
Kodumasinad / Household appliances	14
Santehnika ja suruõhuühendus / Kitchen and compressed air techniques	14
Valgustus ja elekter/ Lighting and electricians	15
Jäätmekäitlusvahendid / Waste handling appliances	16
Koristusteenus / Cleaning services	16
AV-teenused ja –tehnika / AV-services and technics	17
Tõste- ja riputusteenused / Lifting and hanging services	18
Muud teenused / Other services	18
Hüvitised / Amendments	18
Graafikateenused / Graphics services	19
Otsalaualogod ja –tekstid / Fascia logos and texts	20
Kunstlilled ja-puud / Decorative plants	20
Internetiühendus / Internet connections	20
Logistikateenused / Logistics services	20
Toitlustusteenused / Catering services	21
Konverentsiteenused / Conference services	21
Kontserdi-, peo- ja esitlusteenused	22
Renditingimused / Rental terms	23
Maksetingimused / Terms of payment	23
Stendi joonis/Stand sketch	24
Eesti Näituste messikeskus / Estonian Fairs Centre	25
Messikeskuse asukoht ja üldkontaktid / How do get there and general contacts	27
Eksponeendi memo / Exhibitors memo	28

Stendi kujundamine

Stand design



Messiks ettevalmistamisega tasub alustada varakult. Stendi kujundamisel on suur tähtsus, on ju messistend ettevõtte visiitkaart.

Messil osalemise eesmärgid, eksponaatide hulk ja tegevus messistendil määravad ka stendi suuruse ja varustatuse. Loomulikult oluline ka eelarve. Seepärast pakume erinevaid lahendusi.

Pakume palju võimalusi messistendi ehitamiseks.

Valikus on järgmised variandid:

- standardstend on mugavaim võimalus baasstendi tellimiseks juba messile registreerumisel.
- üksikud tooted, millest ehitatakse terve stend või mida saab täiendavalt standardstendile lisada
- erikujuline stend, meie disaineriga koostöös kujundatud erikujuline, ettevõtte imagot väljendav stend
- kliendi enda olemasolevate jooniste järgi ehitatud stend

Abistame kõigis stendi kujundamise ja ehitamisega seonduvates küsimustes. Võtke ühendust ja küsige pakkumist.

Planning your participation in a fair takes time. For a few days your stand is the face to the outside world.

Your goals, quantity of exhibits and the activity on the stand put certain demands on the size and the furnishing. Also the budget has its influence. Therefore we offer you a wide range of alternatives.

We offer you different alternatives.

Please choose a suitable option:

- standard stand is easiest way to order basic stand already when you register for a fair.
- single products of which you can build a whole stand or complete your stand
- design stand, a tailor-made stand designed by one of our designers
- a stand based on your own drawings

We assist you in all matters related to stand building. Please do not hesitate to ask for an offer!

Erikujuline stand

Design stand

Muudame Teie ideed hästi töötavaks messistendiks!



Õnnestunud messistend kujundatakse alati messil osalemise eesmärkidest lähtuvalt. Ettevõtte imago väljendav stand toetab kõige paremini eesmärkide saavutamist. Ehitame Teie messistendi oskuslikult ja organiseerime Teie eest ka kõik sellega kaasneva.

Eesti Näituste disaineritel on rahvusvaheline kogemus väga erinevate erialade erikujuliste standide kujundamisel. Neilt saad erinevaid ideelahendusi.

Võta meiega ühendust ja loome koos stendi millega saavutate soovitud eesmärgi.

The design of a successful fair stand always starts from the goals set for participation at the fair. A stand that reflects your corporate image supports the achievement of your goals best. We'll apply our professional skill in designing and building your stand and take care of all the practical matters for you.

The designers at Estonian Fairs are in a unique position to follow international trends in various fields. They will also be able to offer you the latest ideas for new solutions that will give your ideas concrete shape.

Get in touch with us, and we'll join forces to create a framework for achieving your goals.

Standardstend

Standard stand

Eesti Näituste AS-i poolt korraldatavatel messidel tellitakse standardstend messile registreerumisel. Standardstend sisaldab üldjuhul: ümbritsevad seinaelemendid, otsalaud, vaipkate, üldvalgustus ja pistikupesa.

Standardstendi saab täiendada erineva mööbli ja kujunduselementidega.

Eesti Näituste AS-i poolt mittekorraldatavate messide puhul palume kindlasti täpsustada korraldajalt milliseid elemente standardstend sisaldab.

In exhibitions arranged by Estonian Fairs Ltd, standard stands should be ordered in connection with registration. The stand usually includes walls, fascia, carpet, basic lighting and socket.

A standard stand can be supplemented with different furniture and decorations.

In exhibitions arranged by another organizer than Estonian Fairs Ltd, exhibitors should check with the organizer what constructions are included to the standard stand rental.

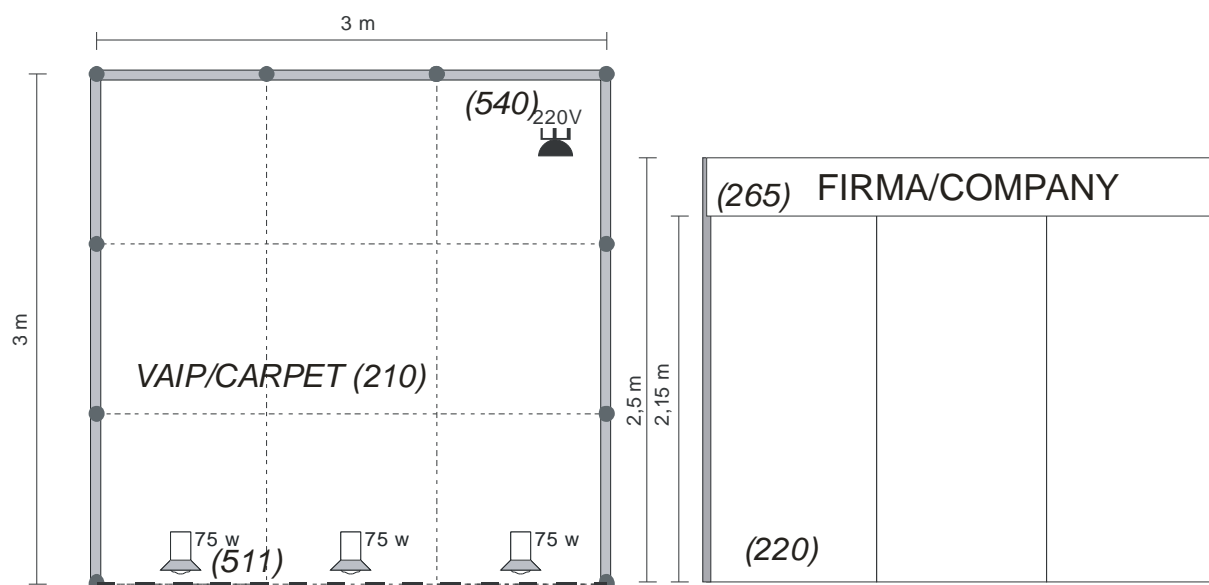

Konstruksioonid / Constructions

220	Seinaelemendid Wall elements	standardised alumiiniumprofiili konstruktsiooniga valged seinad standard aluminium profiles and white walls
265	Otsalaud Fascia board	Puitkilp rippuv või profiilidevaheline valge Wooden hanging or profiles white panel
210	Vaipkate Carpet	rullvaip – helehall, tumehall, punane, sinine, helesinine või roheline rolling carpet – dark grey, red, blue or green

Elekter / Electrics

511	Valge kohtvalgusti lattjuhtmel White sportlight on wired profile
540	Pistikupesa kaitsekontaktiga 220V 1,0kW 4,5A (sisaldab elektri tarbimist) Plug socket 220V, 1,0kW 4,5A (includes consumption)

Profiilide ja kilpide mõõdud Dimensions of profiles and panels

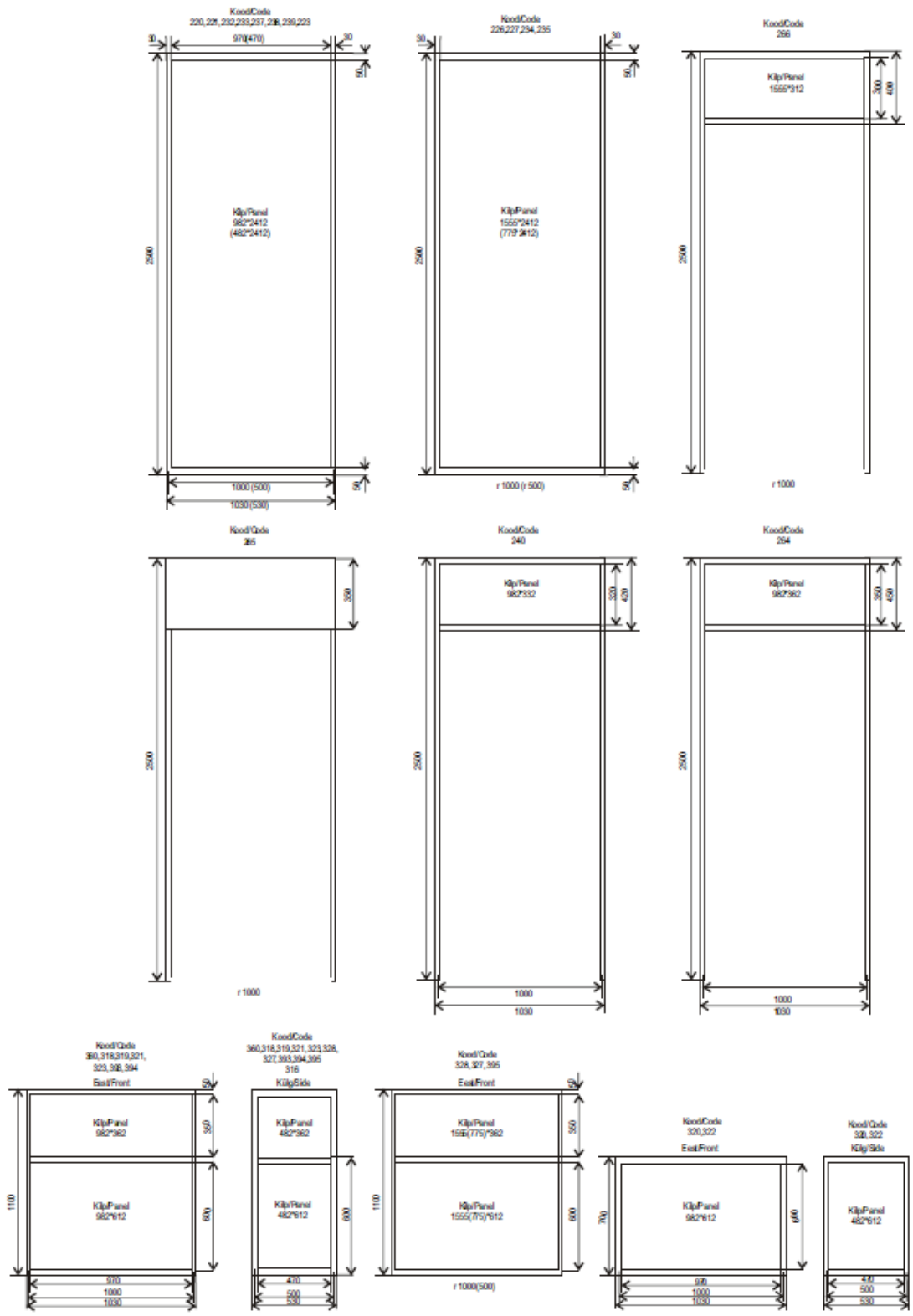

Konstruksioonelemendid / Constructions

Meie Consta Systems® profiilisüsteemil on palju erinevaid laiuse, kõrguse ja vormiga variante. Põhimaterjaliks on alumiiniumprofiilist karkass ja valge seinakilp.

Saadaval on samuti PVC ja BIP akrüülmaterjalist plaadid. Stendi isikupärasemaks muutmiseks on võimalik seinad katta sobivat tooni kilega. Profiili konstruktsioonidele on võimalik kinnitada reklaammaterjale ja bannereid tavalise kileteibiga (pärast messi lõppu kindlasti eemaldada) ja riputuskonksudega.

Our Consta Systems® profile systems come in several widths, heights and shapes. The basic material is an aluminum-profile frame and white board.

PVC boards and BIP acrylic board can also be ordered. To make your stand more personal is possible to cover wall panels with color adhesives. Items can be attached to profile structures using adhesives (must be removed afterwards) or hooks.

Kood Code	Nimetus / Item	Hind € Price €
220	Seinaelement 100*h250cm valge/valge / Wall element 100*h250cm white/white	22,00
221	Seinaelement 50*h250cm valge/valge / Wall element 50*h250cm white/white	18,00
226	Kaarseinaelement r100*h250cm valge/valge / Curved wall element r100*h250cm white/white	67,00
227	Kaarseinaelement r50*h250cm valge/valge / Curved wall element r50*250cm white/white	52,00
232	Seinaelement 100*h250cm akrüül / Wall element 100*250cm acrylic	92,00
233	Seinaelement 50*h250cm akrüül / Wall element 50*250cm acrylic	61,00
234	Kaarseinaelement r100*h250cm akrüül / Curved wall element r100*h250cm acrylic	115,00
235	Kaarseinaelement r50*h250cm akrüül / Curved wall element r50*250cm acrylic	80,00
247	Peegelseinaelement 100*h170cm / Mirror wall element 100*h170cm	65,00
237	Peegelseinaelement 100*h250cm / Mirror wall element 100*h250cm	90,00
238	Peegelseinaelement 50*h=250 cm / Mirror wall element 50*h250cm	45,00
239	Seinaelement PVC 100*h250cm (punane, sinine, kollane, roheline, must) /PVC wall element 100*h250cm (red, blue, yellow, green, black)	65,00
223	Seinaelement BIP 100*h250cm (punane, sinine, kollane, roheline, must) / BIP wall element 100*h250cm (red, blue, yellow, green, black)	25,00
240	Tahvelukselement 100*h250cm lukustatav / Hinged door element 100*h250cm, lockable	35,00
260	Lükandukselement 100*h250cm lukustatav / Folding door element 100*h250cm, lockable	42,00
264	Kardinaelement 100*h250cm / Curtain element 100*h250cm	23,00
252	Laekarkass 1m ² / Frame for ceiling grid 1m ²	10,00
253	Laerest koos karkassiga 97*97cm / Ceiling grid with frame 97*97cm	21,00
254	Laerest koos karkassiga 47*97cm / Ceiling grid with frame 47*97cm	15,00
265	Otsalaud jm. / Fascia board hanging 1m	10,00
266	Kaarotsalaud jm. / Curved fascia board 1m	15,00



Hindadele lisatakse käibemaks 20%. VAT 20% will be added to the prices.

Mööbel / Furniture

Valikus on palju erinevat mööblit igale maitsele. Rendime mööblit ja konstruktsioone ka väljapool messikeskust toimuvatele üritustele.

Our range includes plenty of furniture. We also rent furniture and other exhibition structures for use in events outside Estonian Fairs Centre.



* Inventari on piiratud koguses/ limited amount of inventory

Kood Code	Nimetus / Item	Hind € Price €
	Toolid/Chairs	
300	Tool / Chair	5,00
303	Konverentsitool / Conference chair	10,00
306	Baaritool / Bar chair	15,00



* Inventari on piiratud koguses/ limited amount of inventory

Kood Code	Nimetus / Item	Hind € Price €
	Toolid/Chairs	
310	Laud / Table 70*70 cm	13,00
311	Laud / Table 70*120 cm	16,00
312	Laud / Table 70*180 cm	18,00
313	Laud / Table Ø70 cm	13,00
314	Laud / Table Ø100 cm	16,00
315	Baarilaud / Bar table Ø60 h110 cm	16,00
360	Arvutilaud / PC table 53*103*70 cm	22,00

Hindadele lisatakse käibemaks 20%. VAT 20% will be added to the prices.



318



319



320



321



327*



394*



395*



397*



399

* Inventari on piiratud koguses/ limited amount of inventory

Kood Code	Nimetus / Item	Hind € Price €
Infoletid, kapid ja vitriinid/Info counters, cupboards and showcases		
317	Videoalus/ Video stand 53*53* h110 cm	20,00
316	Infolett usteta / Info counter without doors 53*53 h110 cm	25,00
318	Infolett usteta / Info counter without doors 53*103 h110 cm	33,00
319	Infolett ustega / Info counter with doors 53*103 h110 cm	39,00
328	Kaarinfolaud / Curved info counter without doors r50*h110 cm	41,00
327	Kaarinfolaud / Curved info counter without doors r100*h110 cm	51,00
320	Kapp / Cupboard 53*103 h70 cm	33,00
321	Kapp / Cupboard 53*103 h110 cm	35,00
322	Kapp, lukustatav / Cupboard, lockable 53*103 h70 cm	37,00
323	Kapp, lukustatav / Cupboard lockable 53*103 h110 cm	40,00
392	Vitriin usteta / Showcase without doors 53*53 h110 cm	32,00
393	Vitriin usteta / Showcase without doors 53*103 h110 cm	48,00
394	Vitriin ustega / Showcase with doors 53*103 h110 cm	65,00
395	Kaarvitriin usteta / Curved chowcase without doors r100 h110 cm	85,00
397	Vitriin valgustamata / Showcase 53*53 h250 cm	58,00
398	Vitriin valgustamata / Showcase 53*103 h250 cm	75,00
399	Vitriin valgustatud / Showcase lightened 53*103 h250 cm	97,00

Hindadele lisatakse käibemaks 20%. VAT 20% will be added to the prices.

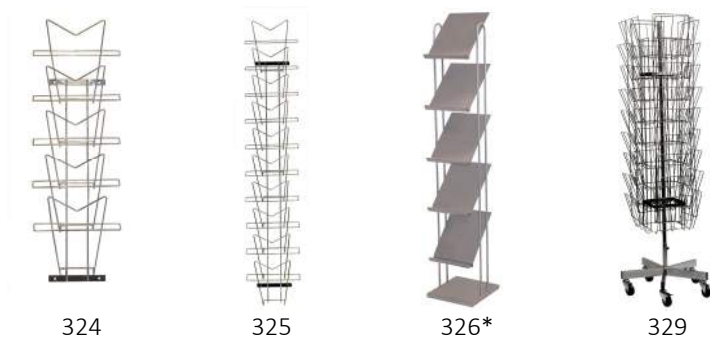

* Inventari on piiratud koguses/ limited amount of inventory

Kood Code	Nimetus / Item	Hind € Price €
Ajakirjaalused/Literature holders		
324	Ajakirjaalus seinale / Literature holder, wall model 5*A4	6,00
325	Ajakirjaalus seinale / Literature holder, wall model 9*A4	10,00
326	Ajakirjaalus jalal / Literature holder, standing 5*A4	24,00
329	Ajakirjaalus ratastel / Literature holder wheeled 40*A4	26,00



Kood Code	Nimetus / Item	Hind € Price €
Lao- ja seinariiulid/Storage and wall shelves		
340	Laoriitul LUNDIA - puit 4-riuliga / 4 shelf storage unit LUNDIA 30*83 h208cm	14,00
342	Laoriitul - valge 5-riuliga/ 5 shelf storage unit 40*93 h180 cm	30,00
380	Seinariitul / Shelf, wall model 30*100 cm	11,00
381	Seinariitul (kald) / Shelf, wall model (tilt) 30*100 cm	12,00

Profiilid/Profiles

Kood Code	Nimetus / Item	Hind € Price €
281	Püstak / Square profile 110 cm	5,00
283	Püstak / Square profile 250 cm	10,00
284	Põõn / Beam profile 27 cm	4,00
285	Põõn / Beam profile 47 cm	5,00
286	Põõn / Beam profile 97 cm	6,00
287	Põõn / Beam profile 197 cm	8,00
288	Põõn / Beam profile 297 cm	11,00
289	Kaarpõõn / Curved profile R515	12,00
290	Kaarpõõn / Curved profile R1015	14,00
291	Syma-Molto 90 profiil/ profile m	18,00
292	Syma-Molto 90 nurgakuubik/ corner cube	10,00

Hindadele lisatakse käibemaks 20%. VAT 20% will be added to the prices.



343



382



385



330



331



332



280



280b



282

Kood Code	Nimetus / Item	Hind € Price €
Töötasapinnad ja poodiumid/Tables for exhibits and podiums		
343a	Töötasapind / Table for exhibits 53*103 h70 cm	19,00
343b	Töötasapind / Table for exhibits 53*103 h90 cm	19,00
343c	Töötasapind / Table for exhibits 53*103 h110 cm	19,00
344a	Töötasapind / Table for exhibits 103*103 h70 cm	22,00
344b	Töötasapind / Table for exhibits 103*103 h90 cm	22,00
344c	Töötasapind / Table for exhibits 103*103 h110 cm	22,00
382	Poodium / Podium 53*103 h40 cm	27,00
383	Poodium / Podium 53*103 h70 cm	29,00
384	Poodium / Podium 53*103 h110 cm	30,00
385	Poodium / Podium 103*103 h40 cm	29,00
386	Poodium / Podium 103*103 h70 cm	30,00
387	Poodium / Podium 103*103 h110 cm	31,00
Muu mööbel/Other furniture		
330	Peegel / Mirror 40*h100 cm	6,00
333	Meigi/peeglilaud 53*103 h200cm (lauaosa h70cm)/ Make-up/dressing table 53*103 h200cm (table h70cm)	35,00
331	Seinanagi / Clothes rack, wall model	6,00
332	Põrandanagi / Clothes rack standing	13,00
280	Piirdepost / Boundary pole	10,00
280a	Kõis piirdepostidele 2,5m (tavaline) / Rope for poles 2,5m (regular)	5,00
280b	Kõis piirdepostidele 2,5m (punane samet) / Rope for poles 2,5m (red velvet)	8,00
282	Piire / Front partition element 100*h105 cm	16,00

Hindadele lisatakse käibemaks 20%. VAT 20% will be added to the prices.

Vaipkatted / Carpets

Meie valikus on mitmeid eri värve plaat- ja rullvaipu. Hind sisaldab paigaldamist, renti ja eemaldamist ning kile eemaldamist enne messi algust.

Our range includes several types of carpet tiles and carpet rolls. Prices include installation, rent and removal as well as removal of plastic cover before fairs starts.

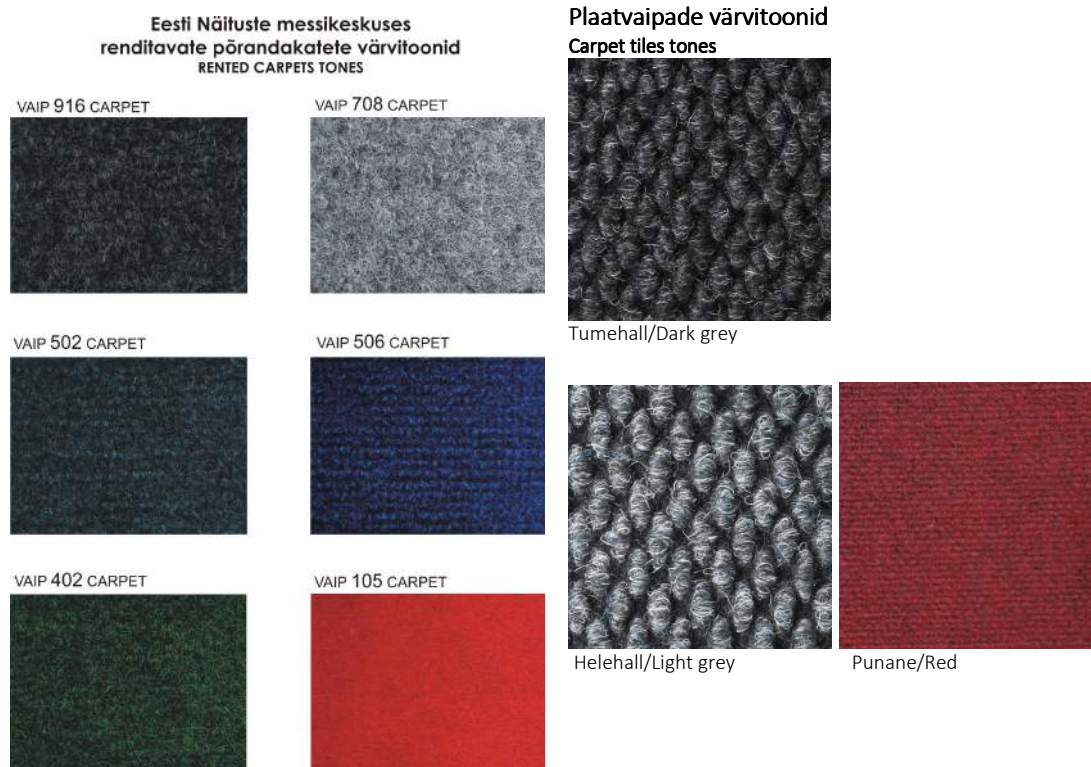

- Teised värvitoonid on saadaval on eritellimusel ning -hinnaga.
- Other tones are available with special order and-price.

Kood Code	Nimetus / Item	Hind € Price €
210	Rullvaip(hall, tumehall, punane, tumesinine, helesinine, roheline) koos paigaldusega/ Carpet roll (grey, black, red, light blue, dark blue, green) with installation 1m ²	5,50
211	Vaibakile koos paigaldusega / Plastic for carpet with intallation 1m ²	1,00
212	Plaatvaip (50*50 cm) (helehall, tumehall, punane) koos paigaldusega / Carpet tiles (0,5*0,5) (light grey, dark grey, red) with installation 1m ²	7,00

Kodumasinad / Household appliances



350



370



370



371*

* Inventari on piiratud koguses/ limited amount of inventory

Kood Code	Nimetus / Item	Hind € Price €
350	Külmutuskapp/ Refrigerator	45,00
370	Kohviaparaat (maht 10 tassi) / Coffee percolator (10 cups)	14,00
371	Täisautomaatne espressomasin (period)/ Espresso maker (period)	99,00

NB! Elektriühendused kohvimasinatele (370 ja 371) ja külmutuskapile (350) on vaja tellida eraldi.
Electrical installations for coffee makers (370 and 371) and refrigerators (350) should be ordered separately.

Santehnika ja suruõhuühendus / Kitchen and compressed air techniques



600



601/603

Kood Code	Nimetus / Item	Hind € Price €
600	Kombineeritud köök (külmik, boiler, pliit, 24h vooluühendus, sis. veeühendus ja kanalisatsioon) / Combined kitchen (sink, hot plate, boiler, refrigerator, water supply, drainage)	200,00
601	Valamu+boiler (sisaldab veeühendust ja kanalisatsiooni) / Sink+boiler (includes water supply and drainage)	175,00
603	Valamu (külm vesi, sisaldab veeühendust ja kanalisatsiooni) / Sink (cold water, includes water supply and drainage)	135,00
605	Veeühendus (s.h. tarbimine) / Water supply	60,00
607	Kanalisatsiooniühendus (võimalusel) / Drainage (if possible)	60,00
608	Suruõhuühendus - 7 atm. 250 l/min. / Compressed air - 7 atm. 250 l/min.	57,00

*Suruõhuühendus üle 7 atm. eritellimusena. Hinnapakumise saamiseks palume pöörduda messi projektijuhi poole.

*Compressed air more than 7 atm. is special order. Price-offer please ask from Project Manager.

Hindadele lisatakse käibemaks 20%. VAT 20% will be added to the prices.

Valgustus ja elekter / Lighting and electrics



520

Kood Code	Nimetus / Item	Hind € Price €
500	Jaotuskilp / Main switch board 220/380V, 16A, 10kW	145,00
501	Jaotuskilp / Main switch board 220/380V, 32A, 20 kW	210,00
Valgustid/Lamps		
510	Kohtvalgusti /Spotlight VIP 75W 230V	45,00
511	Kohtvalgusti lattjuhtmel / Spotlight on wired profile 75W	22,00
512	Kohtvalgusti varrel (50 cm) / Spotlight with holder (50 cm) UFO150W 220V	35,00
513	Kohtvalgusti / Spotlight Crypton 150W 230V	55,00
515	Halogeenvalgusti (lattjuhtmel) / Low voltage light on wired profile 50W 12V	35,00
516	Rippvalgusti metallhaliid (Kuppel) / Metal halide spotlight 400W	75,00
514	Metallhaliidprožektor/Metal halide low voltage light Leo 400W (vajab montaažiks trussingut/needs trussing for installation)	50,00
517	Halogeenprožektor hajuva valgusvooga / Low voltage light, scattered light 300W	45,00
518	Halogeenprožektor hajuva valgusvooga / Low voltage light, scattered light 500W	50,00
519	Prožektor / Ceiling spotlight 1000W	75,00
520	Luminofoorvalgusti (katteta) / Fluorescent light 36W	25,00
Elektriühendused / Electrical connections:		
540	Pistikupesa EU standard kaitsekontaktiga / Plug socket, EU standard 220V 1,0kW 4,5A	25,00
540v	Pistikupesa EU standard kaitsekontaktiga (välipind) / Plug socket, EU standard (outdoor) 220V 1,0kW 4,5A	45,00
542	Pistikupesa EU standard kaitsekontaktiga / Plug socket, EU standard 3,5kW 16A	40,00
542v	Pistikupesa EU standard kaitsekontaktiga (välipind) / Plug socket, EU standard (outdoor) 3,5kW 16A	60,00
545	Pistikupesa külmpapile / Plug socket for refrigerator 220V, 1,0 kW, 24 h	50,00
545v	Pistikupesa külmpapile (välipind) / Plug socket for refrigerator (outdoor) 220V, 1,0 kW, 24 h	65,00
546	Jõupesa EU standard, kaitsekontaktiga / Plug socket, EU standard 380 V, 16 A, 10 kW	95,00
546v	Jõupesa EU standard, kaitsekontaktiga (välipind) / Plug socket, EU standard (outdoor) 380 V, 16 A, 10 kW	110,00
547	Jõupesa EU standard, kaitsekontaktiga / Plug socket, EU standard 380 V, 32 A, 20 kW	165,00
547v	Jõupesa EU standard, kaitsekontaktiga (välipind) / Plug socket, EU standard (outdoor) 380 V, 32 A, 20 kW	220,00

547s	Jõupesa EU standard, kaitsekontaktiga (soojakule) / Plug socket, EU standard (for heated shelter) 380 V, 32 A, 20 kW	100,00
548	Jõupesa EU standard, kaitsekontaktiga (3 päeva) / Plug socket, EU standard (3 days) 380 V, 63 A, 40 kW	320,00
548v	Jõupesa EU standard, kaitsekontaktiga 3 päeva (välipind)/ Plug socket, EU standard 3 days (outdoor) 380 V, 63 A, 40 kW /	360,00
548a	Jõupesa EU standard, kaitsekontaktiga (välipind) iga järgnev päev / Plug socket, EU standard (outdoor) every next day 380 V, 63 A	60,00
560	Pikendusjuhe - kolme pesaga / Outlet cable 220 V (3, 5m)	10,00
Muud teenused/Other services		
825	Elektritööd (tund)/Electrical installation works (hour)	29,00
570	Trussing/ Truss m	18,00
571	Trussingu nurk/Truss corner	20,00

Jäätmekäitlusvahendid / Waste handling appliances



377



378

Kood Code	Nimetus / Item	Hind € Price €
377	Prügikast+kilekotid (prügikasti tühendatakse 1x päevas)/ Waste paper basket + waste bags (emptying once a day)	5,00
377a	Prügikasti lisatühjendus 1x /Additional emptying of waste paper basket 1x	2,00
378	Prügikonteiner (konteinerit tühendatakse 1x päevas) /Waste bag holder (emptying once a day) (100 and 150 l)	16,00
378a	Prügikonteineri lisatühjendus 1x /Additional emptying of waste bag holder 1x	4,00
379	Prügikonteineri kilekotid 10 tk /Waste bags (10 pieces)	7,00
376	Suuremahulise prügi (taara ja ehituspraht) koristamine 1m ³ /Removal of large-scale waste (packages and rubble) 1m ³	15,00

Hindadele lisatakse käibemaks 20%. VAT 20% will be added to the prices.

Koristusteenus / Cleaning services

Kood Code	Nimetus / Item	Hind € Price €
827-1	Stend suurusega kuni 10 m ² /Stand up to 10 m ²	18,00
827-2	Stend suurusega 11 - 20 m ² /Stand 11 - 20 m ²	25,00
827-3	Stend suurusega 21 - 30 m ² /Stand 21 - 30 m ²	35,00
827-4	Stend suurusega 31 - 50 m ² /Stand 31 - 50 m ²	55,00
827-5	Stend suurusega 51-100 m ² /Stand 51-100 m ²	60,00
827-6	Stendi suurus üle 100 m ² iga järgnev 50 m ² /Stand larger than 100 m ² , every next 50 m ²	40,00
Stendi igapäevane koristamine messiperioodil - sisaldab: põranda pühkimine ja pesemine või tolmu imemine, mööblilt tolmu pühkimine ja prügikasti tühjendamine./ Stand cleaning during whole fair period: includes floor sweeping and wiping with a damp cloth or vacuum-cleaning, wiping of furniture and emptying of waste basket.		
828	Koristamine 1xpäevas 1m ² /Cleaning once a day 1m ²	1,00

Hindadele lisatakse käibemaks 20%. VAT 20% will be added to the prices.

AV-teenused ja –tehnika / AV-services and technics



751/752



748

Kood Code	Nimetus / Item	Hind € Price €
Telerid/TV-s		
751	32" (81 cm) Televiisor (päev) /Flatt TV (day)	23,00
751a	32" (81 cm) Televiisor (periood) /Flatt TV (period)	48,00
752	42" (107cm) Televiisor (päev) /Flatt TV (day)	48,00
752a	42" (107cm) Televiisor (periood) /Flatt TV (period)	97,00
749	46" Televiisor (periood) /Flatt TV (period)	140,00
748	50" Televiisor (periood) /Flatt TV (period)	200,00
747	60" Televiisor (periood) /Flatt TV (period)	220,00
746	64/65" Televiisor (periood) /Flatt TV (period)	280,00
750	75" Televiisor (periood) / Flatt TV (period)	350,00
744	82" Televiisor (periood) / Flatt TV (period)	450,00
745	Põrandajalg 32-64" ekraanile (periood)/ TV 32-64" holder/leg standing (period)	55,00
346	TV seinakinnitus (paar)/ TV wall fastener (pair)	11,00
CD, DVD-mängijad/CS, DVD-players		
707	CD mängija rent (päev)/CD player (day)	17,00
754	DVD mängija (päev) /DVD player(day)	16,00
754a	DVD mängija (periood) /DVD player (period)	29,00
Projektorid/Projectors		
419	DATA-projektor (päev) / DATA-projector (day)	50,00
Ekraanid ja tahvlid/Screens and whiteboards		
758	1,5*1,5m ekraan statiiviga (päev)/ Screen with holder (day)	17,00
759	2*3 m ekraan (päev) / Screen (day)	14,00
760	1*1,5 m ekraan (päev) / Screen (day)	4,00
416	Pabertahvel (tund) / Flipchart (hour)	4,00
415	Laserpliiats (tund) / Laser pointer (hour)	4,00
Helivõimendus/Sound system		
708	Võimendi+kõlari rent (päev) / Amplifier rent (day)	20,00
711	Raadiomikrofon (1 tk/päev) / Radio microphone rent (day)	20,00
Reklaamikanal eksponentidele/Marketing channel for exhibitors		
705	Reklaami edastamine infokanalis (1 min.)/ Advertising in info-channel (min.)	8,00
Muud teenused/Other services		
700	Helitehnik, videotehnik (tund)/ Audio and video technician (hour)	30,00

Tõste- ja riputusteenused / Lifting and hanging services

Kood Code	Nimetus / Item	Hind € Price €
829-1	Tõstuk (kuni 3t) koos juhiga - 15 min. /Forklift with driver (max load 3t) - 15 min.	10,00
829-2	Tõstuk (kuni 3t) koos juhiga - 1 tund/ Forklift with driver (max load 3t) - one hour	35,00
829-3	Tõstuk (kuni 3t) koos juhiga - 4 tundi /Forklift with driver (max load 3t) - four hours	88,00
829-4	Tõstuk (kuni 3t) koos juhiga - päev (8 tundi) /Forklift with driver (max load 3t) - day (8 hours)	140,00
850	Käsitõstuk ROCLA (30 minutit) / Lift ROCLA - 30 minutes	12,00
870-1	Korvtõstuk - 1/2 tundi / Lift - 1/2 hour	46,00
870-2	Korvtõstuk - 1 tund / Lift - one hour	70,00
870-3	Korvtõstuk - iga järgnev tund (juhul kui kasutatakse üle 1 h)/ Lift - every next hour (when used more than 1 hour)	46,00
Riputuspunktid (1 riputuspunkt ja trosside allalaskmine laest) / Hanging points (1 hanging point for hanging flags, banners and cables from the ceiling)		
NBI Juhul kui halli tehnilised tingimused seda võimaldavad/If halls technical conditions allow		
890-1	Kuni 5 kg (1 riputuspunkt) / Up to 5 kg (1 hanging point)	45,00
890-2	Kuni 50 kg (1 riputuspunkt) / Up to 50 kg (1 hanging point)	75,00
890-3	Kuni 100 kg (1 riputuspunkt) / Up to 100 kg (1 hanging point)	110,00
895	Tali/ Pulley	30,00

Muud teenused / Other services

Kood Code	Nimetus / Item	Hind € Price €
830	Laopinna üür (alusele pakitud) min 1 m ³ /periood / Storage rental (packed on the pallet) min 1m ³ /period	30,00
824	Näitusestendi kujundustööd (tund)/ Designwork of the stand (hour)	29,00
826	Transportitööline (tund) / Transport worker (hour)	21,00
862	Tulekustuti 6l rent (periood) / Fire extinguisher 6l rental (period)	35,00

Hüvitised / Amendments

Kood Code	Nimetus / Item	Hind € Price €
880	Eksponeendi viibimine näitusehallis väljaspool lepingus sätestatud kellaaega / Working in exhibition hall beyond the time determined in contract	70,00
820	Seinaelemendi puhastamine kilest 1tk / Removal of adhesive tape from wall element 1 pc.	30,00
834	Profiilide puhastamine kilest 1 tk / Removal of adhesive tape from profiles 1 pc	20,00
835	Seinaelemendi 100*250cm rikkumine / Damaging of wall panel 100*250cm	35,00
836	Seinaelemendi 50*250cm rikkumine / Damaging of wall panel 50*250cm	25,00
837	Otsalaua rikkumine jm / Damaging of fascia board m	10,00
838	Püstaku 250cm rikkumine / Damage on 250cm square profile	23,00
839	Põõna 97cm rikkumine / Damage on 97cm beam profile	22,00
210a	Vaiba teibi eemaldamine 1jm (kliendi vaip), põranda rikkumine / Removal of carpet tape m (customer's carpet), floor damage	1,90
210b	Vaiba teibi eemaldamisel põranda rikkumine 1m ² / Floor damaging during carpet tape removal 1 m ²	4,50

Hindadele lisatakse käibemaks 20%. VAT 20% will be added to the prices.

Graafikateenused / Graphics services

Elavda oma stendi piltidega. Teostame eritellimusena pilte ja bannereid erinevatele materjalidele: kleepkilele, kangale ja erinevatele plaat-materjalidele (kapa, pvc, acrüül, makrolon, viscom jne.). Banderollid, bännerid ja muud kleepetööd – muudame sinu stendi visuaalselt atraktiivseks!



Kapaplaadile trükitud pildid.
Image prints on light-weight board (kapa).

Print services. We can supply your stand custom made prints on several materials: self-adhesive vinyl, fabrics, plates, light-weight board, acryl etc. Banners, image enlargements, roll up stands, special colour coverings – let's make your stand attractive!



Erinevat värvi kiledega kaetud otsalauad, infoletid, logod ja tekstid.
Special colour coverings on fascias and desks, logos, image prints on the walls and desks.



Kasuta suuri pilte – nendega saab katta terve stendi.
All wall elements covered with prints.



Kleepkilettekstid ja pildid seinaelementidel.
Self-adhesive vinyl prints attached to the wall elements.



Kasuta ka stendi kohal olevat ruumi, et muuta ennast hästi nähtavaks.
Laest saab alla riputada lippe ja bannereid.
Use also the space above your stand. Banners, flags and sign boards can be suspended from the ceiling.



Infolettide paneelid on võimalik katta nii, et konstruktsiooni ei ole näha.
Info stand's front panels covered with prints made on pvc board.

Otsalaualogod ja –tekstid / Fascia logos and texts

Ettevõtte logo või tekst on oluline informatsioon messikülastajale. Ära unusta neid tellimast! Logod tuleks saata e-postiga vektorigraafika formaadis ai, eps, cdr.

If you like to have a logo, please send it using vectorized files: Illustrator (ai) or other eps files.

Kood Code	Nimetus / Item	Hind € Price €
801	Kleptäht/Adhesive letter h10 cm HELVETICA medium	1,00
802	Kleptäht/ Adhesive letter h11-15 cm HELVETICA medium	2,00
810	Riigi lipp otsalaual/State flag on the fascia 20*30 cm	4,00
821	Ühevärviline logo/ One-colour logo h30*max 100 cm	19,00
822	Kahevärviline logo/Two-colour logo h30*max 100 cm	25,00
823	Kolmevärviline logo/Three-colour logo h30*max 100 cm	31,00
824	Logo- ja muude kujundusfailide töötlemine (tund) / Processing logos and other design files (hour)	29,00
612	Takjateip, selle kinnitamine profiilile ja eemaldamine jm / Zip fix tape, fastening to the profile and removal 1m	1,50
236	Seinaelemendi kiletamine värvilise kilega/Covering wall elements with coloured adhesives 1m ²	11,00

Kunsttaimed / Decorative plants



Kood Code	Nimetus / Item	Hind € Price €
611	Dekoratiivpuu /Artificial tree	18,00

Hindadele lisatakse käibemaks 20%. VAT 20% will be added to the prices.

Internetiühendus / Internet connections

Traadiga Internetiühendus / Wired Internet connection



Eksponeendil on võimalik tellida oma stendile traadiga Internetiühendus kiirusega kuni 10 Mbit/s kõigis messihallides Linxtelecom Estonia OÜ e-postiaadressil: sales@linxtelecom.ee, telefonil 622 3360 või Interneti-aadressil: www.linxtelecom.ee/mess.

It is possible for the Exhibitor to place an order for a wired Internet connection with a speed of up to 10 Mbit/s in all trade fair halls by the e-mail address of Linxtelecom Estonia LLC: sales@linxtelecom.ee, by phone +372 622 3360 or at the Internet address: www.linxtelecom.ee/mess.

WIFI Elisalt / Wifi connection from Elisa

Eesti Näituste messikeskuses pakub tasuta wifi-teenust Elisa Eesti AS.

Elisa is providing WIFI access at the Estonian Fairs Centre.

Logistikateenused / Logistics services

EkspONENT korraldab eksponaatide transpordi konkreetsele näitusele või messile ja tagasi sihtkohta oma kulul ning vastutab kõigi oma eksponaatidega seonduvate tolliformaalsuste täitmise eest. Tolli- ja transporditeenuseid on võimalik tellida: UPEX LS OÜ – Pirita tee 28, 10127 Tallinn; tel 6137433; faks 6112851, GSM 511 9947, e-post: upex@upex.ee, www.upex.ee.

The Exhibitor shall organise the transport of the Exhibits to the particular exhibition or trade fair and back to the place of destination at his/her own expense and be responsible for the completion of customs formalities connected to all his/her Exhibits. Orders on customs and transport services can be placed: UPEX LS Ltd – Pirita Street 28, 10127 Tallinn, Estonia; phone +372 6137433; fax +372 6112851, GSM +372 511 9947, e-mail: upex@upex.ee, www.upex.ee.

Toitlustusteenused / Catering services

Messi ekspONENTide ja teenindava personali toitlustamise eest hoolitseb Näituste Baari OÜ.

Fuajee ülakorrusel töötab messiperioodil restoran-bistroo mahutavusega kuni 140 kohta ning B-hallis töötab kohvik-baar mahutavusega kuni 50 kohta.

Messi ajal on võimalik tellida toitlustusteenust ka stendile. Lisainformatsioon telefonil +372 501 5095 Liivia Eensalu.

Exhibitors and service personal catering is done by Näituste Baari OÜ.

Upper floor of lobby is working restaurant-bistro capacity max 140 places and in B-hall is working coffee-bar capacity max 50 places.

There is possibility to order catering services to the stand. Additional information by phone +372 501 5095 Liivia Eensalu.



Konverentsiteenused / Conference services

Meie konverentsiruumides on võimalik korraldada nõupidamisi, seminare ja erinevaid kliendiüritusi.

In our conference premises is possible to hold meetings, seminars and customer events.

A-paviljoni I korruse konverentsisaal:

- 180 kohta teatristiilis (max 50 lisatooli paigutamise võimalus);
- DATA-projektor
- magnettahtvel
- pabertahvel

The conference room on the ground floor of Exhibition Hall A:

- 180 places in theatre-style (a possibility of max. 50 additional chairs);
- data projector
- magnetic display board
- flipchart

A-paviljoni II korruse konverentsiruum:

- 120 kohta teatristiilis või 60 kohta seminaristiilis või 40 kohta ümarlauastiilis;
- DATA-projektor
- pabertahvel

The conference room on the first floor of Exhibition Hall A:

- 120 places in theatre-style or 60 places in workshop-style or 40 places in round-table-style;
- data projector
- flipchart

B-paviljoni II korruse seminariruum:

- 30 kohta teatristiilis või 20 kohta seminaristiilis või 14 kohta ümarlauastiilis;
- DATA-projektor;
- pabertahvel

The workshop room on the first floor of Exhibition Hall B:

- 30 places in theatre-style or 20 places in workshop-style or 14 places in round-table-style;
- data projector;
- flipchart



Kontserdi-, peo- ja esitlusteenused

Eesti Näituste messikeskuse paviljonid on sobivad suure vaatajate-kuulajate arvuga kontsertide korraldamiseks. Messikeskuses on esinenud sellised maailmanimega staarid ja ansamblid nagu Brian Adams, Joe Cocker, Savage Garden, Jethro Tull, Kraftwerk, Gotan Project, Kimmo Pohjonen, Dieter Bohlen koos ansambliga Blue System jt.

Eesti Näituste AS osutab kontserdikorraldajaile alljärgnevaid teenuseid:

- ruumide üürimine;
- esinejate puhke- ja managemendi tööruumide ehitamine ja sisustamine;
- telefoni- ja internetiühendus puhke- ja tööruumidesse;
- tõste- ja transporditeenused;
- riidehoiu- ja koristusteenus;
- turvateenus;
- parklateenus.

Messikeskuse paviljonid on sobivad nii suur- kui väike- ja keskmise suurusega firmade pidude, kliendivastuvõtude jms korraldamiseks.



Eesti Näituste AS osutab peokorraldajaile alljärgnevaid teenuseid:

- projektijuhtimisteenused;
- ruumide üürimine ja kujundamine;
- dekooriteenused;
- tantsupõranda ehitamine;
- laudade-toolide üürimine;
- lavaehitus;
- tõste- ja transporditeenused;
- esinejate riietus- ja puhkeruumide ehitamine ja sisustamine;
- riidehoiu- ja koristusteenus;
- turvateenus;
- parklateenus;
- koostööpartnerite abil:

- toitlustusteenus;
- heli- ja valgustusteenused;
- meelelahutusprogrammi koostamine ja korraldamine;
- lilleseadeteenused.



Eesti Näituste messikeskuse paviljonid ja avväljakud on sobivad kliendipäevade, toote- ja teenusesitluste, näituste jm ürituste korraldamiseks, mille raames lisanduvad Eesti Näituste AS-i poolt ürituse korraldajale osutatavatele eelnimetatud teenustele veel:

- näituse- ja esitlusinventari üürimine;
- stendiehitusteenused;
- konverentsiteenused;
- kleebisreklaamiteenused

Peo, esitluse, vastuvõtu ja näituse korraldamine messikeskuses võimaldab realiseerida Teie julgemagi fantaasia, luua just Teie ürituseks sobiva ruumiprogrammi, interjööri ja meeleolu ning muuta iga üritus kordumatuks ning meeldejäävaks sündmuseks.

Renditingimused / Rental terms

Konstruksioonide ja mööbli rendi hind sisaldab renti kogu perioodi jooksul ning nende montaaži ja demontaaži. Juhul, kui juba stendile toodud elemendi tellimus annuleeritakse siis on Eesti Näituste AS-l õigus kohaldada selle rendihinda täies mahus. Renditavad konstruktsioonid ja mööbel on kasutamiseks vaid sisetingimustes. Seinaelementidele ja mööblile reklaamide ja bännerite kinnitamiseks võib kasutada vaid kergelt eemaldatavaid teipe ja riputuskonkse. Teibid tuleb pärast messi lõppu eemaldada. Juhul kui seinaelemendid, mööbel või muu inventar rikutakse on Eesti Näituste AS-l õigus nõuda nende hüvitamist.

The price for construction and furnishings covers the rental and installation and dismantling costs for the whole exhibition. In case an ordered product delivered to the stand is cancelled, Estonian Fairs Ltd reserves the right to charge full price. Constructions and furnishings available for rent are intended for interior use only. Objects may be fixed to wall elements and furniture only with light adhesives and decoration hooks. The adhesives must be removed by the exhibitor. If wall elements, furniture or other items is damaged Estonian Fairs Ltd reserves the right to charge the exhibitor the cost of damaged items

Maksetingimused / Terms of payment

Hindadele lisatakse kehtiv käibemaks. Maksetingimus on 10 päeva, juhul kui teisiti ei märgita.

Messi eksponeerimispäeval tehtud tellimustele kehtib hinnalisa 50%.

Reklamatsioonid ja pretensioonid tuleb esitada messi ajal teenindusbüroosse.

Applicable VAT will be added to prices. Terms 10 days net, unless otherwise indicated.

Orders made during exhibition layout days will be subject to a 50% surcharge. Complaints shall be issued during the exhibition to the Exhibitor Service.















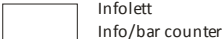



Stendi joonis

Stand sketch

Firma/Company	Mess/Fair
Kontaktisik/Contact person	Stendi number/Stand number
E-mail	Telefon/Phone

1m	1m															
															Kood/Code	Kogus/Qnt.

Kõikidele kujundus- ja konstruksioonelementidele palume joonisel lisada koodid
 Please mark codes of furniture and constructions to the sketch

 Seinaelement Wall element	 Laud Table	 Akrüülsein Wall panel acrylic	 Külmutuskapp Refrigerator
 Otsalaud Fascia board	 Infolett Info/bar counter	 Peegel Mirror	 Pistikupes Plug socket
 Tahveluks Hinged door	 Tool Chair	 Riiul Lundia 4 shelf storage unit	 Kohtvalgusti Lamp
 Lükanduks Folding door	 Seinariiu Shelf	 Vitriin Showcase	 Baaritool Bar chair
 Kardin Curtain	 Seinanagi Clother rack	 Kraanikauss Sink	

Tekst otsalaul/Text on the fascia																			

Allkiri/Signature	Kuupäev/Date
-------------------	--------------

Eesti Näituste messikeskus / Estonian Fairs Centre

Tehniline informatsioon / Technical information

A-hall I korrus

* Pindala 665 m²

* Kõrgused:

laeni 3,0m
barjääri ülaosani 5,01m
keskosas laeni 6,8m

* Põranda maksimaalne kandevõime 2000 kg/m²

* Tarbitava elektrivõimsuse piirmäär: 165 P max/kW; 750 (3*250) J max/A

* Kaubavärvad:

A1: kõrgus 2,3m, laius 3,8m

A-hall II korrus

* Pindala 837 + 203m² (konverentsisaal)

* Kõrgused:

talani 2,8m
laeni 3,7m
barjääri kõrgus 0,97m

* Põranda maksimaalne kandevõime 400 kg/m²

* Tarbitava elektrivõimsuse piirmäär: 165 P max/kW; 750 (3*250) J max/A

* Kaubavärvad:

A2: kõrgus 2,55m, laius 3,55m

B-hall I korrus

* Pindala 996m²

* Kõrgused:

talani 3,5m
barjääri ääreni 4,99m
keskosast talani 6,8m

* Põranda maksimaalne kandevõime 4000kg/m²

* Tarbitava elektrivõimsuse piirmäär: 257 P max/kW; 1170 (3*390) J max/A

* Hallis on veevõtu ja kanalisatsiooniühendused

* Kaubavärvad:

B1: kõrgus 3,1m, laius 4,2m

B-hall II korrus

* Pindala 940 m²

* Kõrgused:

talani 2,8m
laeni talade vahelt 3,9m
barjääri kõrgus 0,95m

* Põranda maksimaalne kandevõime 300 kg/m²

* Tarbitava elektrivõimsuse piirmäär: 257 P max/kW; 1170 (3*390) J max/A

* A ja B halli vaheliste uste mõõdud: kõrgus 1,8m; laius 1,5m

C-hall

* Pindala 4800 m²

* Kõrgused:

fermideni 8,0m
maksimaalne ehituskõrgus 7,5m
fermide vahe 10,0m

* Põranda maksimaalne kandevõime 4000 kg/m²

* Tarbitava elektrivõimsuse piirmäär: 389 P max/kW; 1770 (3*590) J max/A

* Hallis on veevõtu ja kanalisatsiooniühendused

* Kaubavärvad:

C1: kõrgus 4,04m, laius 4,8m

C2: kõrgus 4,04m, laius 5,8m

C3: kõrgus 3,5m, laius 2,8m

C4: kõrgus 4,04m, laius 4,8m

C5: kõrgus 4,78m, laius 4,48m

Fuajee ja C-halli vaheline uks: kõrgus 2,4m, laius 4,8m

D-halli ja C-halli vaheline uks: kõrgus 3,5m, laius 8,4m

D-hall

NBI Ekspositsioonipinnana kasutatav üksnes kaitsepõranda paigaldamisel.

Eksponeerimisvõimalused ja -tingimused kooskõlastatakse eelnevalt Eesti Näituste

ASiga.

* Pindala 1995m²

* Kõrgused:

keskosas 7,2m (valgustiteni), fermideni 8,7m
seinast 1,5m kaugusel 5,4m

* Tarbitava elektrivõimsuse piirmäär: 389 P max/kW; 1770 (3*590) J max/A

* Kaubavärvad:

D1: (kalle/tõus 7cm): kõrgus 3,3m, laius 2,7m

D2: kõrgus 4,9m, laius 3,8m

D3: (kalle/tõus 7cm): kõrgus 3,3m, laius 2,7m

A-hall I floor

* Surface 665 m²

* Height:

up to the ceiling 3,0m
up to the upper block of the barrier 5,01m
up to the ceiling in the middle of the hall 6,8m

* Maximum loading capacity of floor 2000 kg/m²

* Maximum limit of electric output: 165 P max/kW; 750 (3*250) J max/A

* Service door:

A1: height 2,3m, width 3,8m

A-hall II floor

* Surface 837 + 203m² (conference hall)

* Height:

up to the beam 2,8m
up to the ceiling 3,7m
height of the barrier 0,97m

* Maximum loading capacity of floor 400 kg/m²

* Maximum limit of electric output: 165 P max/kW; 750 (3*250) J max/A

* Service door:

A2: height 2,55m, width 3,55m

B-hall I floor

* Surface 996m²

* Height:

up to the beam 3,5m
up to the upper block of the barrier 4,99m
up to the beam in the middle of the hall 6,8m

* Maximum loading capacity of floor 4000kg/m²

* Maximum limit of electric output: 257 P max/kW; 1170 (3*390) J max/A

* Connections to plumbing and drainage are available

* Service door:

B1: height 3,1m, width 4,2m

B-hall II floor

* Surface 940 m²

* Height:

up to the beam 2,8m
up to the ceiling between beams 3,9m
barrier height 0,95m

* Maximum loading capacity of floor 300 kg/m²

* Maximum limit of electric output: 257 P max/kW; 1170 (3*390) J max/A

* Doors between halls A and B hall: height 1,8m; width 1,5m

C-hall

* Surface 4800 m²

* Height:

up to the beams 8,0m
Maximum building height 7,5m
space between beams 10,0m

* Maximum loading capacity of floor 4000 kg/m²

* Maximum limit of electric output: 389 P max/kW; 1770 (3*590) J max/A

* Connections to plumbing and drainage are available

* Service doors:

C1: height 4,04m, width 4,8m

C2: height 4,04m, width 5,8m

C3: height 3,5m, width 2,8m

C4: height 4,04m, width 4,8m

C5: height 4,78m, width 4,48m

Door between lobby and hall C: height 2,4m, width 4,8m

Door between halls D and C: height 3,5m, width 8,4m

D-hall

NBI Exhibiting possibilities and conditions will be settled additionally with Estonian

Fairs Ltd

* Surface 1995m²

* Height:

In the middle of the hall 7,2m (up to lamps), up to beams 8,7m
from the wall 1,5m height 5,4m

* Maximum limit of electric output: 389 P max/kW; 1770 (3*590) J max/A

* Service doors:

D1: (slope/rise 7cm): height 3,3m, width 2,7m

D2: height 4,9m, width 3,8m

D3: (slope/rise 7cm): height 3,3m, width 2,7m

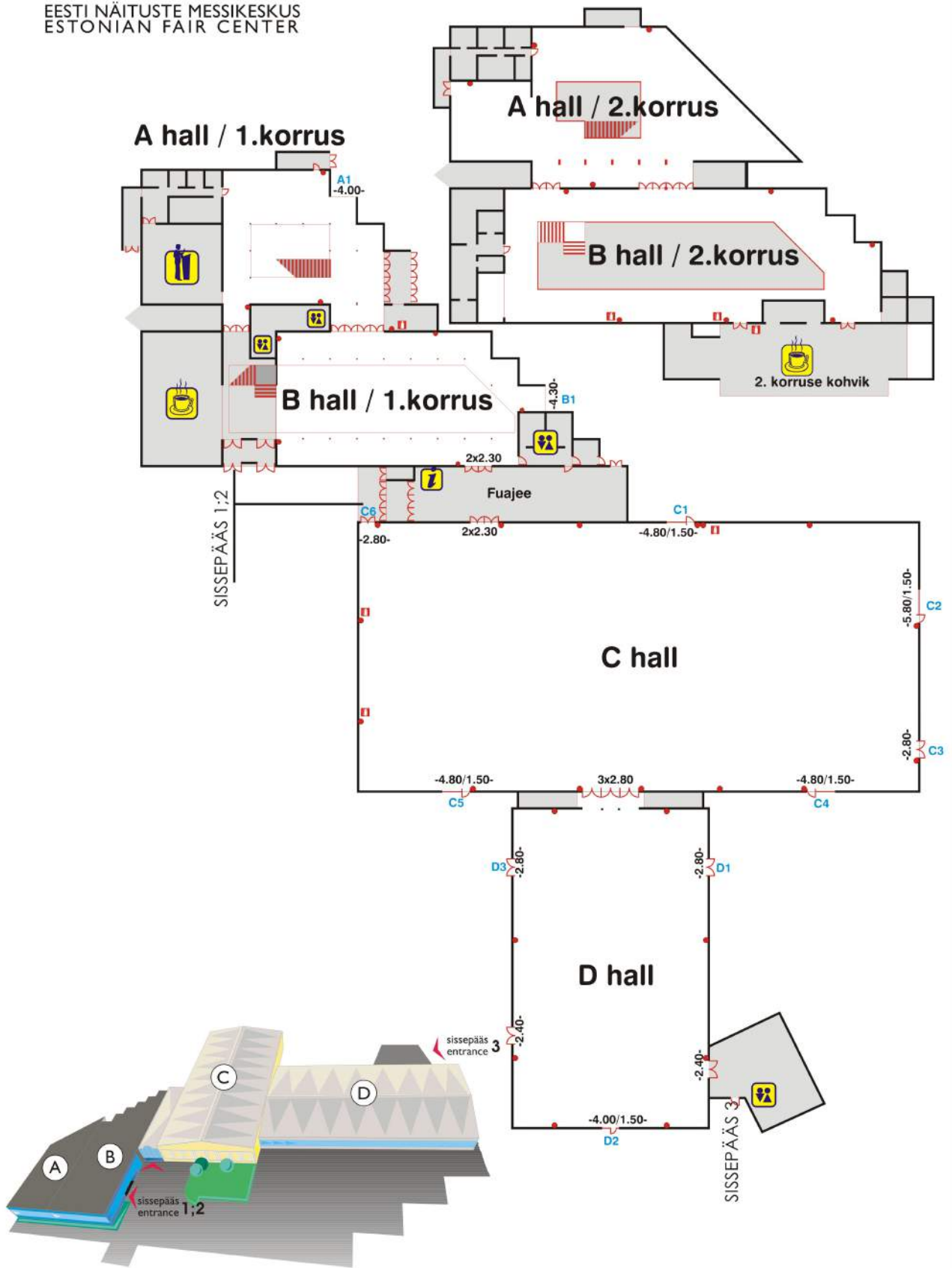

Messikeskuse asukoht ja üldkontaktid

How do get there and general contacts

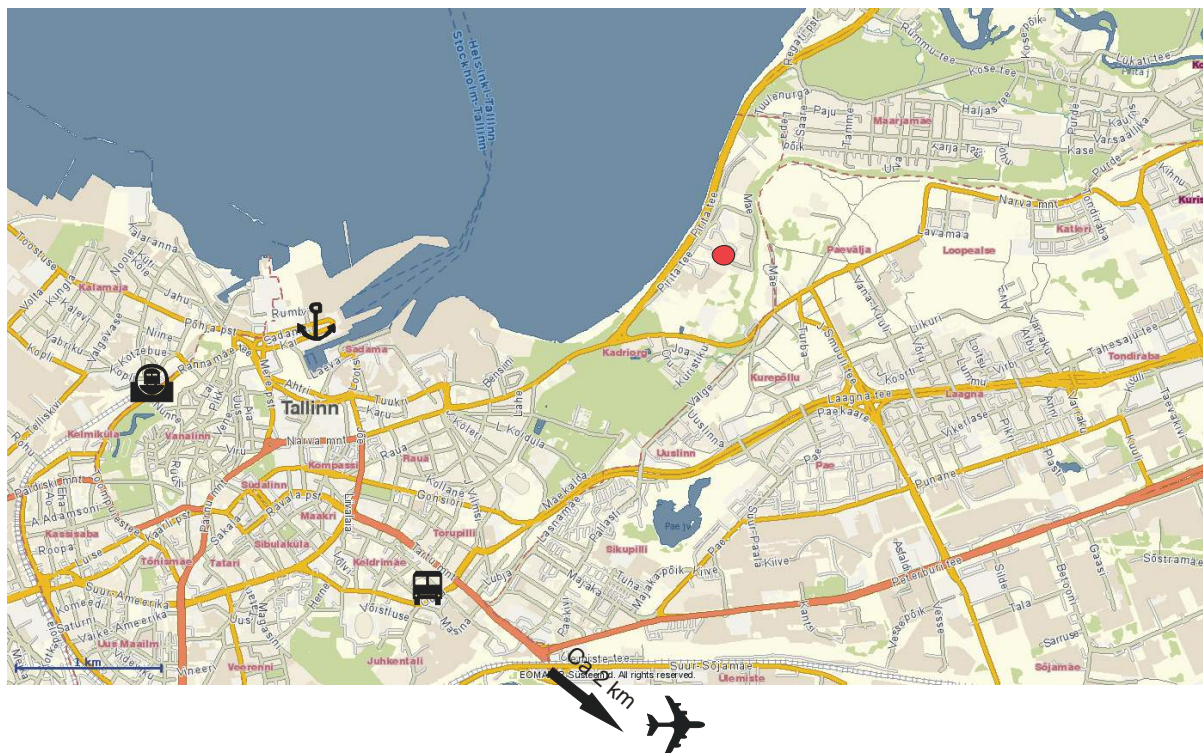

Eesti Näituste messikeskus asub vaid 10 minuti kaugusel kesklinnast ja siia saab mugavalt bussidega number 1, 1A, 5, 8, 34 ja 38 - Lauluväljaku peatus.

Estonian Fairs Center locates only 10 minutes from city centre. You can drive easily to us by busses no 1, 1A, 5, 8, 34 and 38 - bus stop "Lauluväljak".

Eesti Näituste AS
Pirita tee 28, 10127 Tallinn
Reg. nr. 10017313
KMKR.: EE100295692
Telefon 6137337, faks 6137447
e-post: fair@fair.ee

Estonian Fairs Ltd
28 Pirita Road, 10127 Tallinn, Estonia
Reg. no. 10017313
VAT id No: EE100295692
Tel. +372 6137337, fax +372 6137447
e-mail: fair@fair.ee

www.fair.ee

Eksponeendi memo / Exhibitors memo

Kutsed klientidele ja koostööpartneritele	Invitations to customers
Ehitajapassid	Construction and dismantling passes
Eksponeendi passid	Exhibitor's passes schedules
Montaaži ja demontaaži graafikud	Construction and dismantling graphics
Parklakaardid	Parking cards
Messikataloogi informatsioon korraldajale	Catalogue information to organiser
Teadanded uutest toodetest korraldajale	Product news information to organiser
Pressiteated	Press releases
Töötajate informeerimine	Releases to personnel
Juhtkonna informeerimine	Releases to principals
Reklaam	Advertising
Lähetused ja hotellid	Travel and accommodation reservations
Stendil töötava meeskonna ettevalmistus	Training of personnel
Reklaamvoldikud, meened, stendimeeskonna rõivastus jms	Brochures, gifts, uniforms etc.
Koosoleku- ja nõupidamisruumide rent	Renting of conference facilities
Stendi toitlustus	Catering services
Stendi kujundus	Designing stand
Stendi ehitamise ja turvalisuse juhendid	Guidelines for stand construction and safety
Stendijoonise kinnitamine korraldaja poolt	Approval for stand design from the organiser
Konstruksioonid	Constructions
Mööbel	Furnishing
Vaipkate	Carpet
Valgustus ja elekter	Lighting and electrics
AV-tehnika	AV-equipment
Tekstid, logod, pildid ja muu graafiline teostus	Texts, logos, prints, other graphics
(Kunst)lilled	Plants
Vesi, kanalisatsioon ja suruõhk	Water, drainage and compressed air
Koristus	Cleaning
Turvateenus	Security services
Jäätmekäitlus	Dump service
Transport, laadimised jms kaubakäsitlus	Transportation, lifting and forwarding
Kindlustused	Insurances
Müügiluba	Retail sale permit
Kliendiinfo kogumine	Collecting customer register
Tagasiside messikorraldajale ürituse ajal	Response to the organiser during the exhibition
Stendi demontaaž ja logistika	Dismantling and forwarding
Järgnevad tegevused	Follow-up actions
Küsimustiku tagastamine korraldajale	Questionnaire to the organiser after the exhibition